

APPROVAL SHEET

WR10, WR12, WR08, WR06, WR04

±1%, ±5%

General Purpose Chip Resistors

Size 1210, 1206, 0805, 0603, 0402

Automotive Grade AEC Q200 Qualified

Customer : _____

Approval No : _____

Issue Date : _____

Customer Approval :

FEATURE

1. Automotive grade AEC Q-200 qualified
2. 100% CCD inspection
3. RoHS compliant and Lead free products

APPLICATION

- Automotive application
- Consumer electrical equipment
- EDP, Computer application
- Telecom application

DESCRIPTION

The resistors are constructed in a high grade ceramic body (aluminum oxide). Internal metal electrodes are added at each end and connected by a resistive paste that is applied to the top surface of the substrate. The composition of the paste is adjusted to give the approximate resistance required and the value is trimmed to within tolerance by laser cutting of this resistive layer.

The resistive layer is covered with a protective coat. Finally, the two external end terminations are added. For ease of soldering the outer layer of these end terminations is a Tin (lead free) alloy.

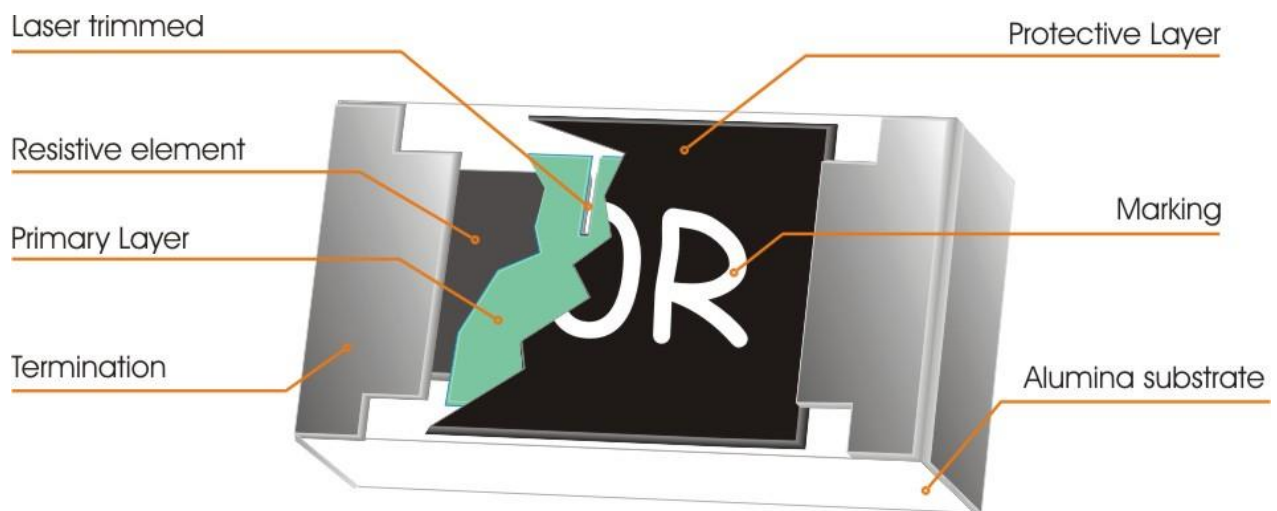
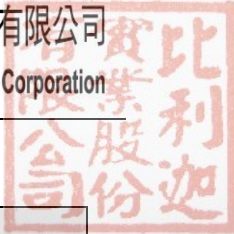

Fig 1. Construction of a Chip-R



QUICK REFERENCE DATA

Item	General Specification									
	Series No.	WR10	WR12	WR08	WR06	WR04				
Size code	1210(3225)	1206(3216)	0805(2012)	0603(1608)	0402(1005)					
Resistance Range	1Ω~10MΩ (±5% tolerance), Jumper 1Ω~10MΩ (±1% tolerance)									
Resistance Tolerance	±1% E96/E24	±5% BE24	±1% E96/E24	±5% E24	±1% E96/E24	±5% E24	±1% E96/E24	±5% E24	±1% E96/E24	±5% E24
TCR (ppm/°C)	R > 1MΩ ≤ ± 200		10Ω < R ≤ 1MΩ ≤ ± 100		R ≤ 10Ω -200~+400		≤ ± 200		≤ ± 100	
Max. dissipation @ T _{amb} =70°C	1/3 W	1/4 W	1/8 W	1/10 W	1/16 W					
Max. Operation Voltage (DC or RMS)	200V	200V	150V	75V	50V					
Max. Overload Voltage (DC or RMS)	400V	400V	300V	150V	100V					
Operation temperature	-55 ~ +155°C									

Note :

- This is the maximum voltage that may be continuously supplied to the resistor element, see "IEC publication 60115-8"
- Max. Operation Voltage : So called RCWV (Rated Continuous Working Voltage) is determined by

$$RCWV = \sqrt{\text{Rated Power} \times \text{Resistance Value}} \text{ or Max. RCWV listed above, whichever is lower.}$$
- The resistance of Jumper is defined <0.05Ω.

DIMENSIONS (unit : mm)

	WR10	WR12	WR08	WR06	WR04
L	3.10 ± 0.10	3.10 ± 0.10	2.00 ± 0.10	1.60 ± 0.10	1.00 ± 0.05
W	2.60 ± 0.10	1.60 ± 0.10	1.25 ± 0.10	0.80 ± 0.10	0.50 ± 0.05
T	0.55 ± 0.10	0.60 ± 0.15	0.50 ± 0.15	0.45 ± 0.15	0.35 ± 0.05
Tb	0.50 ± 0.20	0.45 ± 0.20	0.40 ± 0.20	0.30 ± 0.15	0.25 ± 0.10
Tt	0.50 ± 0.20	0.50 ± 0.20	0.40 ± 0.20	0.30 ± 0.10	0.20 ± 0.10

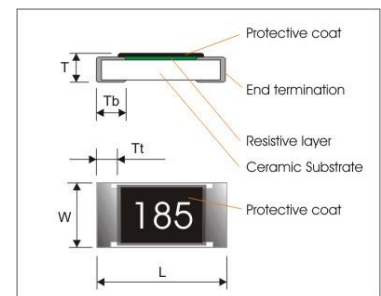

MARKING

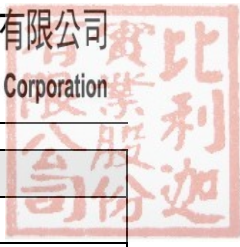

Size \ Nr. Of digit of code\tolerance	±5%	±1%
1210 (3225)	3-digits marking	4-digits marking
1206 (3216)	3-digits marking	4-digits marking
0805 (2012)	3-digits marking	4-digits marking
0603 (1608)	3-digits marking	3-digits marking
0402(1005)	NO MARKING	

3-digits marking (±5% : 1206 & 0805 & 0603)

Each resistor is marked with a three digits code on the protective coating to designate the nominal resistance value.

3-digits marking (±1% : 0603)

Nominal resistance	Description
1.E-24 series	As 0603 WR06X ±5%.
2.E-96 series	The 1st two digit codes are referring to the CODE on the table, the 3rd code is the index of resistance value : Y=10 ⁻² , X=10 ⁻¹ , A=10 ⁰ , B=10 ¹ , C=10 ² , D=10 ³ , E=10 ⁴ , F=10 ⁵ EX : 17.8Ω=25X, 178Ω=25A, 1K78 =25B 17K8=25C, 178K=25D, 1M78=25E
3. Remark	There is no marking for the items are not under E-24 and E-96 series

CODE	R_value	CODE	R_value	CODE	R_Value	CODE	R_value	CODE	R_value	CODE	R_value	CODE	R_value	CODE	R_value
01	100	13	133	25	178	37	237	49	316	61	422	73	562	85	750
02	102	14	137	26	182	38	243	50	324	62	432	74	576	86	768
03	105	15	140	27	187	39	249	51	332	63	442	75	590	87	787
04	107	16	143	28	191	40	255	52	340	64	453	76	604	88	806
05	110	17	147	29	196	41	261	53	348	65	464	77	619	89	825
06	113	18	150	30	200	42	267	54	357	66	475	78	634	90	845
07	115	19	154	31	205	43	274	55	365	67	487	79	649	91	866
08	118	20	158	32	210	44	280	56	374	68	499	80	665	92	887
09	121	21	162	33	215	45	287	57	383	69	511	81	681	93	909
10	124	22	165	34	221	46	294	58	392	70	523	82	698	94	931
11	127	23	169	35	226	47	301	59	402	71	536	83	715	95	953
12	130	24	174	36	232	48	309	60	412	72	549	84	732	96	976

4-digits marking (±1% : 1210/1206/0805)

Each resistor is marked with a four digits code on the protective coating to designate the nominal resistance value.

RESISTANCE	10Ω	12Ω	100Ω	6800Ω	47000Ω
3-digits marking (1206 & 0805 & 0603 ±5%)	100	120	101	682	473
4-digits marking	10R0	12R0	1000	6801	4702

FUNCTIONAL DESCRIPTION

Product characterization

Standard values of nominal resistance are taken from the E24 series for resistors with a tolerance of $\pm 5\%$, and E96 series for resistors with a tolerance of $\pm 1\%$. The values of the E24/E96 series are in accordance with "IEC publication 60063"

Derating

The power that the resistor can dissipate depends on the operating temperature; see Fig.2

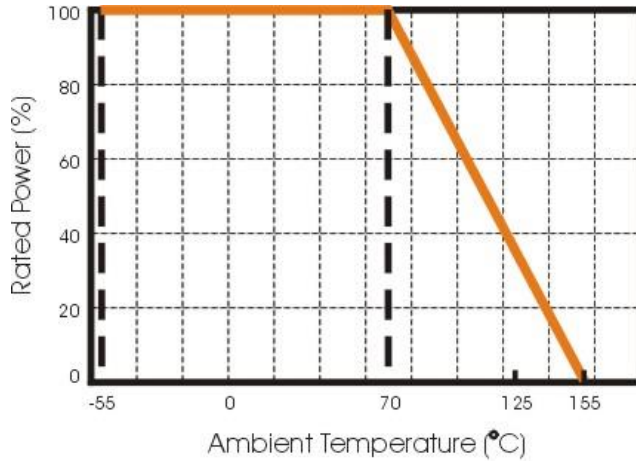

Figure 2 Maximum dissipation in percentage of rated power as a function of the ambient temperature for WR12, WR08, WR06, WR04

MOUNTING

Due to their rectangular shapes and small tolerances, Surface Mountable Resistors are suitable for handling by automatic placement systems. Chip placement can be on ceramic substrates and printed-circuit boards (PCBs). Electrical connection to the circuit is by individual soldering condition. The end terminations guarantee a reliable contact.

SOLDERING CONDITION

The robust construction of chip resistors allows them to be completely immersed in a solder bath of 260°C for 10 seconds. Therefore, it is possible to mount Surface Mount Resistors on one side of a PCB and other discrete components on the reverse (mixed PCBs).

Surface Mount Resistors are tested for solderability at 235°C during 2 seconds. The test condition for no leaching is 260°C for 30 seconds. Typical examples of soldering processes that provide reliable joints without any damage are given in Fig 3.

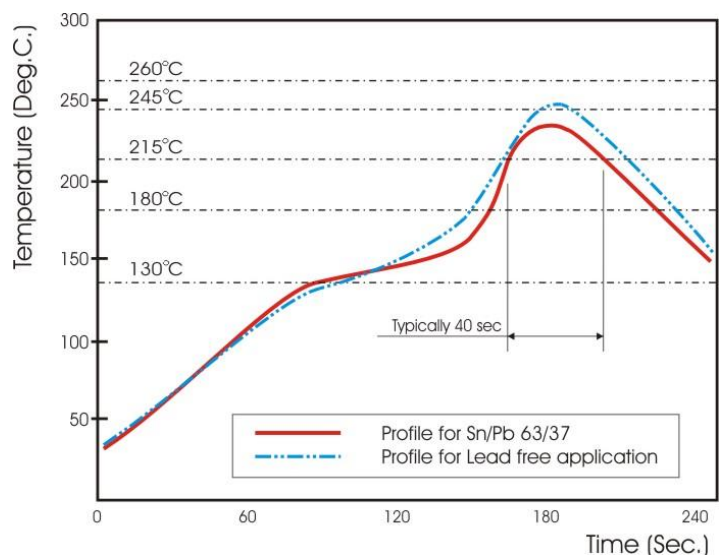

Fig 3. Infrared soldering profile for Chip Resistors

CATALOGUE NUMBERS

The resistors have a catalogue number starting with

WR12	X	472_	J	T	L	J
Size code	Type code	Resistance code	Tolerance	Packaging code	Termination code	Special code
WR10: 1210	X :	$\pm 5\%$, E24: 2 significant digits followed by no. of zeros and a blank	F : $\pm 1\%$	T : 7" Reeled taping	L= Sn base (lead free)	J = Automotive grade AEC Q200 compliant
WR12 : 1206	$\pm 5\%$, 1 Ω ~ 10M Ω		J : $\pm 5\%$	Q : 10" Reeled taping		
WR08 : 0805	$\pm 1\%$, 10 Ω ~ 1M Ω		P : Jumper	G : 13" Reeled taping		
WR06 : 0603	W :	4.7 Ω =4R7_		D : 7" Reeled taping (0402 20kpcs/RL)		
WR04 : 0402	$\pm 1\%$, < 10 Ω ; >1M Ω	10 Ω =100_				
		220 Ω =221_				
		Jumper =000_				
		("_" means a blank)				
		$\pm 1\%$, E24+E96: 3 significant digits followed by no. of zeros				
		102 Ω =1020				
		37.4K Ω =3742				

WR10, WR12, WR08, WR06:

1. Reeled tape packaging : 8mm width paper taping 5000pcs per 7" reel, 10kpcs per 10" reel, 20kpcs per 13" reel.
2. Bulk packaging : 5000pcs per poly-bag

WR04:

1. Reeled tape packaging : 8mm width paper taping 10,000pcs per reel,
2. Bulk packaging : 10,000pcs per poly-bag



TEST AND REQUIREMENTS

Essentially all tests are carried out according to the schedule of IEC publication 115-8, category **LCT/UCT/56**(rated temperature range : **Lower Category Temperature, Upper Category Temperature**; damp heat, long term, 56 days). The testing also meets the requirements specified by EIA, EIAJ and JIS.

The tests are carried out in accordance with IEC publication 68, "Recommended basic climatic and mechanical robustness testing procedure for electronic components" and under standard atmospheric conditions according to IEC 60068-1, subclause 5.3. Unless otherwise specified, the following value supplied :

Temperature: 15°C to 35°C.

Relative humidity: 45% to 75%.

Air pressure: 86kPa to 106 kPa (860 mbar to 1060 mbar).

All soldering tests are performed with midly activated flux.

TEST	PROCEDURE / TEST METHOD	REQUIREMENT	
		Resistor	Ω
Electrical Characteristics JISC5201-1: 1998 Clause 4.8	- DC resistance values measurement - Temperature Coefficient of Resistance (T.C.R) Natural resistance change per change in degree centigrade. $\frac{R_2 - R_1}{R_1(t_2 - t_1)} \times 10^6 \text{ (ppm/}^\circ\text{C)} \quad t_1 : 20^\circ\text{C}+5^\circ\text{C}-1^\circ\text{C}$ R ₁ : Resistance at reference temperature R ₂ : Resistance at test temperature	Within the specified tolerance Refer to "QUICK REFERENCE DATA"	<50mΩ
Resistance to soldering heat(R.S.H) MIL-STD-202 method 210	Un-mounted chips completely immersed for 10±1second in a SAC solder bath at 270°C ±5°C	ΔR/R max. ±(1.0%+0.05Ω) no visible damage	<50mΩ
Solderability J-STD-002	a) Bake the sample for 155°C dwell time 4hrs/ solder dipping 235°C/ 5sec. b) Steam the sample dwell time 1 hour/ solder dipping 260°C/ 7sec.	95% coverage min., good tinning and no visible damage	
Temperature cycling JESD22 Method JA-104	1000 cycles, -55°C ~ +155°C, dwell time 30min. / 1min. max. transition time	ΔR/R max. ±(1.0%+0.05Ω) No visible damage	<50mΩ
Moisture Resistance MIL-STD-202 method 106	65±2°C, 80~100% RH, 10 cycles, 24 hours/ cycle	ΔR/R max. ±(1.0%+0.05Ω) No visible damage	<50mΩ
Bias Humidity MIL-STD-202 method 103	1000+48/-0 hours; 85°C, 85% RH, 10% of operation power	ΔR/R max. ±(2.0%+0.10Ω) No visible damage	<50mΩ
Operational Life MIL-STD-202 method 108	1000+48/-0 hours; 35% of operation power, 125±2°C	ΔR/R max. ±(2.0%+0.1Ω) No visible damage	<50mΩ

TEST	PROCEDURE / TEST METHOD	REQUIREMENT	
		Resistor	0Ω
High Temperature Exposure MIL-STD-202 Method 108	1000+48/-0 hours; without load in a temperature chamber controlled 155±3°C	ΔR/R max. ±(2.0%+0.10Ω) No visible damage	<50mΩ
Board Flex AEC-Q200-005	Resistors mounted on a 90mm glass epoxy resin PCB(FR4), bending once 2mm for 10sec.	ΔR/R max. ±(1.0%+0.05Ω) No visible damage	<50mΩ
Terminal strength AEC-Q200-006	Force: 1.8Kg, (only 1Kg for 0402)Test time: 60±1sec.	No remarkable damage or removal of the terminations	
Thermal shock MIL-STD-202 method 107	Test -55 to 155°C / dwell time 15min/ Max transfer time 20sec 300cycles	ΔR/R max. ±(1.0%+0.05Ω) No visible damage	<50mΩ
ESD AEC-Q200-002	Test contact 1.0KV (0.5KV for 0402 only)	ΔR/R max. ±(1.0%+0.05Ω) No visible damage	<50mΩ
Short Time Overload JISC5201-1: 1998 Clause 4.13	2.5 times RCWV or max. overload voltage, for 5seconds	ΔR/R max. ±(2.0%+0.10Ω) No visible damage	<50mΩ
Load life in Humidity JISC5201-1: 1998 Clause 4.24	1000 +48/-0 hours, loaded with RCWV or Vmax in humidity chamber controller at 40°C±2°C and 90~95% relative humidity, 1.5hours on and 0.5 hours off	ΔR/R max. ±(2%+0.10Ω) No visible damage	<50mΩ
Load life (endurance) JISC5201-1: 1998 Clause 4.25	1000 +48/-0 hours, loaded with RCWV or Vmax in chamber controller 70±2°C, 1.5 hours on and 0.5 hours off	ΔR/R max. ±(2%+0.10Ω) No visible damage	<50mΩ

TEST CONDITION FOR JUMPER (0 Ω)

Item	WR10	WR12	WR08	WR06	WR04
Power Rating At 70°C	1/3W	1/4W	1/8W	1/10W	1/16W
Resistance	MAX.50mΩ				
Rated Current	2.5A	2A	1.5A	1A	1A
Peak Current	6A	5A	3.5A	3A	2A
Operating Temperature	-55 ~ +155°C				



PACKAGING

Paper Tape specifications (unit :mm)

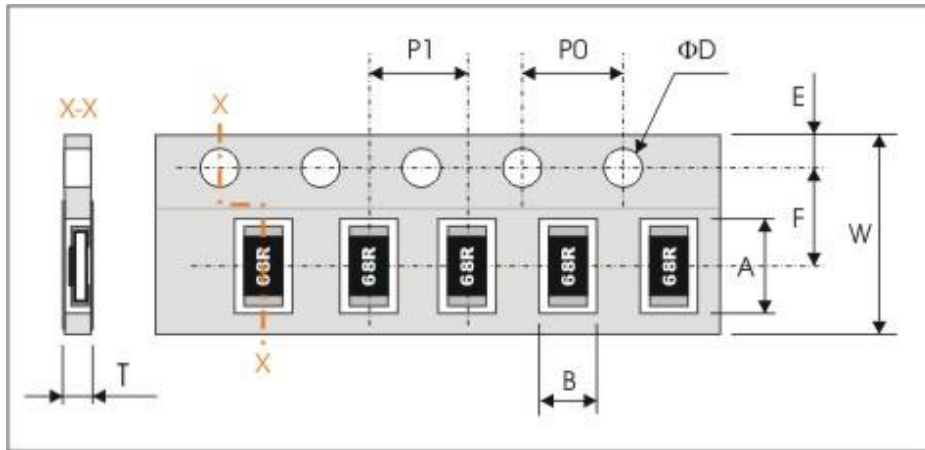

Series No.	A	B	W	F	E
WR10	3.60±0.20	3.00±0.20	8.00±0.30	3.50±0.20	1.75±0.10
WR12	3.60±0.20	2.00±0.20			
WR08	2.40±0.20	1.65±0.20			
WR06	1.90±0.20	1.10±0.20			
WR04	1.20±0.10	0.70±0.10			

Series No.	P1	P0	ΦD	T
WR10/ WR12 / WR08	4.00±0.10	4.00±0.10	Φ1.50 ^{+0.1} _{-0.0}	Max. 1.0
WR06				0.65±0.05
WR04				0.40±0.05

7" Reel dimensions

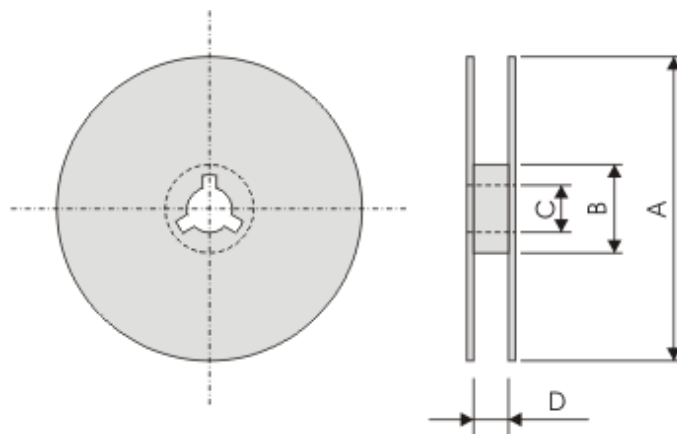

Symbol	A	B	C	D
(unit : mm)	Φ178.0±2.0	Φ60.0±1.0	13.0±0.2	9.0±0.5