



APPROVAL SHEET

WW12X, WW08X, WW06X, WW04X

±1%, ±5%

Thick Film Low Ohm Chip Resistors
RoHS Exemption free and Lead free
Size 1206, 0805, 0603, 0402

*Contents in this sheet are subject to change without prior notice.



FEATURE

1. High power rating and compact size
2. High reliability and stability
3. Reduced size of final equipment
4. RoHS exemption free and Lead free products

APPLICATION

- Power supply
- PDA
- Digital meter
- Computer
- Automotives
- Battery charger
- DC-DC power converter

DESCRIPTION

The resistors are constructed in a high grade ceramic body (aluminum oxide). Internal metal electrodes are added at each end and connected by a resistive paste that is applied to the top surface of the substrate. The composition of the paste is adjusted to give the approximate resistance required and the value is trimmed to nominated value within tolerance which controlled by laser trimming of this resistive layer.

The resistive layer is covered with a protective coat. Finally, the two external end terminations are added. For ease of soldering the outer layer of these end terminations is Tin (lead free) alloy.

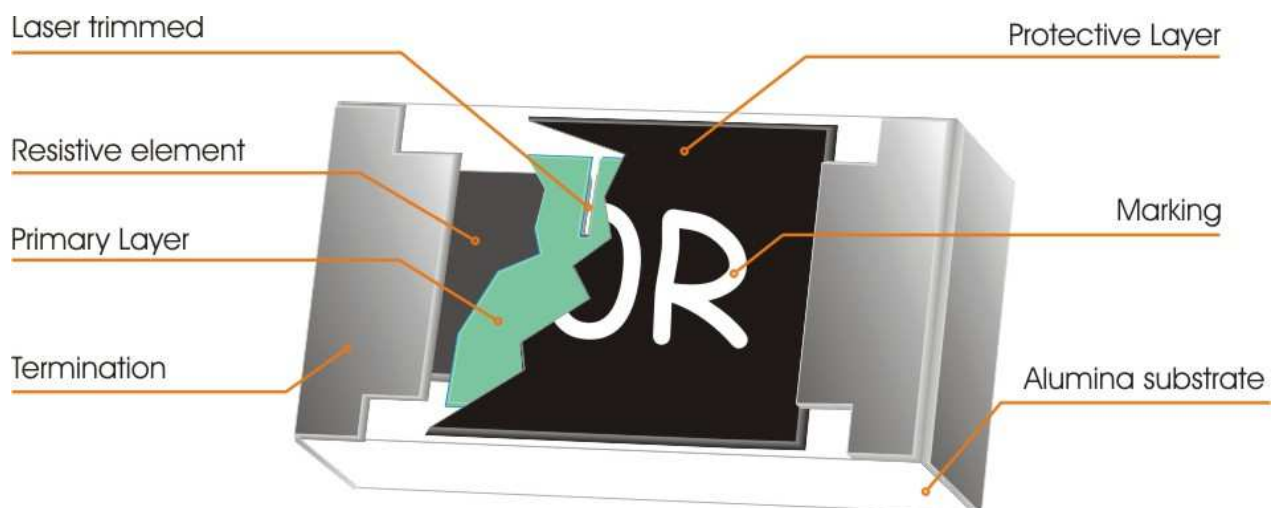
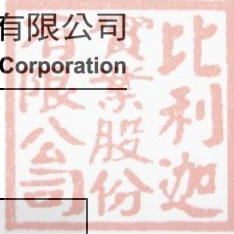

Fig 1. Construction of Chip-R



QUICK REFERENCE DATA

Item	General Specification			
	WW12X	WW08X	WW06X	WW04X
Series No.	WW12X	WW08X	WW06X	WW04X
Size code	1206 (3216)	0805 (2012)	0603 (1608)	0402(1005)
Resistance Tolerance	±5%, ±1%			
Resistance Range	0.010Ω ~ 0.976Ω	0.020Ω ~ 0.976Ω	0.10Ω ~ 0.976Ω	
TCR (ppm/°C)	0.01Ω ≤ Rn < 0.05Ω	≤ 2100 ppm/°C	≤ 1500 ppm/°C	N/a
	0.05Ω ≤ Rn < 0.10Ω	≤ 1000 ppm/°C	≤ 1000 ppm/°C	N/a
	0.10Ω ≤ Rn < 0.50Ω	≤ 500 ppm/°C	≤ 500 ppm/°C	≤ 500 ppm/°C
	0.50Ω ≤ Rn < 1Ω	≤ 400 ppm/°C	≤ 300 ppm/°C	≤ 600 ppm/°C
Max. dissipation at T _{amb} =70°C	1/4 W	1/8 W	1/10 W	1/16 W
Max. Operation Voltage (DC or RMS)	200V	100V	50V	
Max. Overload voltage (DC or RMS)	400V	200V	100V	
Climatic category (IEC 60068)	55/155/56			

Note :

1. This is the maximum voltage that may be continuously supplied to the resistor element, see "IEC publication 60115-8"
2. Max. Operation Voltage : So called RCWV (Rated Continuous Working Voltage) is determined by

$$RCWV = \sqrt{\text{Rated Power} \times \text{Resistance Value}} \text{ or Max. RCWV listed above, whichever is lower.}$$

MECHANICAL DATA

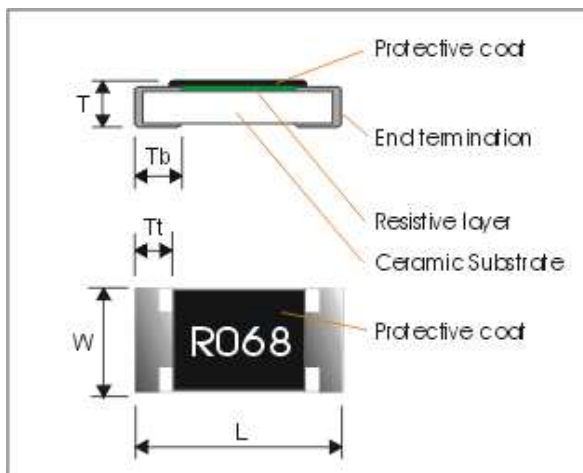

Symbol	WW12X	WW08X	WW06X	WW04X
L	3.10 ± 0.10	2.00 ± 0.10	1.60 ± 0.10	1.00 ± 0.05
W	1.60 ± 0.10	1.25 ± 0.10	0.80 ± 0.10	0.50 ± 0.05
T	0.60 ± 0.15	0.50 ± 0.15	0.45 ± 0.15	0.35 ± 0.05
Tt	0.50 ± 0.20	0.40 ± 0.20	0.30 ± 0.10	0.20 ± 0.10
Tb	0.45 ± 0.20	0.40 ± 0.20	0.30 ± 0.20	0.25 ± 0.10



MARKING

- **4-digits marking for 1206, 0805 size**

Each resistor is marked with a four-digit code on the protective coating to designate the nominal resistance value.

- **3-digits marking for 0603 size**

Each resistor is marked with a three -digit code on the protective coating to designate the nominal resistance value.

- WW04X series has no marking on the product overcoat for both 5% & 1%.
- Marking code list.

1. Material No. :WW series
2. Type & Digital code :

Type	Res. < 1R (E24 +E96 series)	Type	Res. < 1R (E24 +E96 series)
1210	4 digital code	2010	4 digital code
1206	4 digital code	1218	4 digital code
0805	4 digital code	0603	3 digital code
2512	4 digital code	0402	No marking

3. R-value limit : < 1R running value
4. Marking code rule for E24 series & E96 series :

4.1.	1210/1206/0805/2512/2010/1218 type (1% & 5%) : 4 digits for running value of E24 & E96 series. "R" followed by 3 significant digits Ex : 0.002R=R002 0.020R=R020 0.200R=R200				
4.2.	0603 type (1% & 5%) : 3 digits for running value of E24 & E96 series.				
	Item	Rule	Series	Res. limit	Example Remark
	(1)	"R" followed by 2 significant digits if the 4th digit is "0"	E24	100mR~910mR	220mR: R22 Table6.1
	(2)	The 1st two digit codes are referring to the CODE on the table, the 3rd code is the index of resistance value : "Z"	E96	100mR~976mR	178mR: 25Z 221mR: 34Z Table6.2
	(3)	The 3rd code is the index of resistance value : "M" Ps. "M" equals 'm', means 1/1000	-	1mR ~99mR	75mR: 75M 2mR: 02M Table6.3
	(4)	Others are no marking printed.			

4.3. E24 series standard Res list:

Item	R_value	Item	R_value	Item	R_value	Item	R_value	Item	R_value
1	100	6	160	11	270	16	430	21	680
2	110	7	180	12	300	17	470	22	750
3	120	8	200	13	330	18	510	23	820
4	130	9	220	14	360	19	560	24	910
5	150	10	240	15	390	20	620	-	-

4.4. E96 series standard Res. & CODE table:
(1) 0603 : refer to the CODE and R value.
(2) Others: refer to the R value only.

CODE	R_value	CODE	R_value	CODE	R_value	CODE	R_value	CODE	R_value
01	100	21	162	41	261	61	422	81	681
02	102	22	165	42	267	62	432	82	698
03	105	23	169	43	274	63	442	83	715
04	107	24	174	44	280	64	453	84	732
05	110	25	178	45	287	65	464	85	750
06	113	26	182	46	294	66	475	86	768
07	115	27	187	47	301	67	487	87	787
08	118	28	191	48	309	68	499	88	806
09	121	29	196	49	316	69	511	89	825
10	124	30	200	50	324	70	523	90	845
11	127	31	205	51	332	71	536	91	866
12	130	32	210	52	340	72	549	92	887
13	133	33	215	53	348	73	562	93	909
14	137	34	221	54	357	74	576	94	931
15	140	35	226	55	365	75	590	95	953
16	143	36	232	56	374	76	604	96	976
17	147	37	237	57	383	77	619	-	-
18	150	38	243	58	392	78	634	-	-
19	154	39	249	59	402	79	649	-	-
20	158	40	255	60	412	80	665	-	-



FUNCTIONAL DESCRIPTION

Product characterization

Standard values of nominal resistance are taken from the E96 & E24 series for resistors with a tolerance of $\pm 5\%$ & $\pm 1\%$. The values of the E24/E96 series are in accordance with "IEC publication 60063".

Derating curve

The power that the resistor can dissipate depends on the operating temperature; see Fig.2

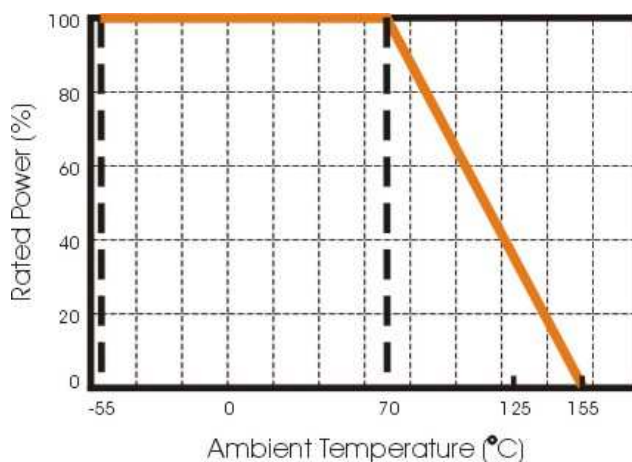

Figure 2 Maximum dissipation in percentage of rated power as a function of the ambient temperature

MOUNTING

Due to their rectangular shapes and small tolerances, Surface Mountable Resistors are suitable for handling by automatic placement systems.

Chip placement can be on ceramic substrates and printed-circuit boards (PCBs).

Electrical connection to the circuit is by individual soldering condition.

The end terminations guarantee a reliable contact.

SOLDERING CONDITION

The robust construction of chip resistors allows them to be completely immersed in a solder bath of 260°C for 10 seconds. Therefore, it is possible to mount Surface Mount Resistors on one side of a PCB and other discrete components on the reverse (mixed PCBs).

Surface Mount Resistors are tested for solderability at 235°C during 2 seconds. The test condition for no leaching is 260°C for 30 seconds. Typical examples of soldering processes that provide reliable joints without any damage are given in Fig 3.

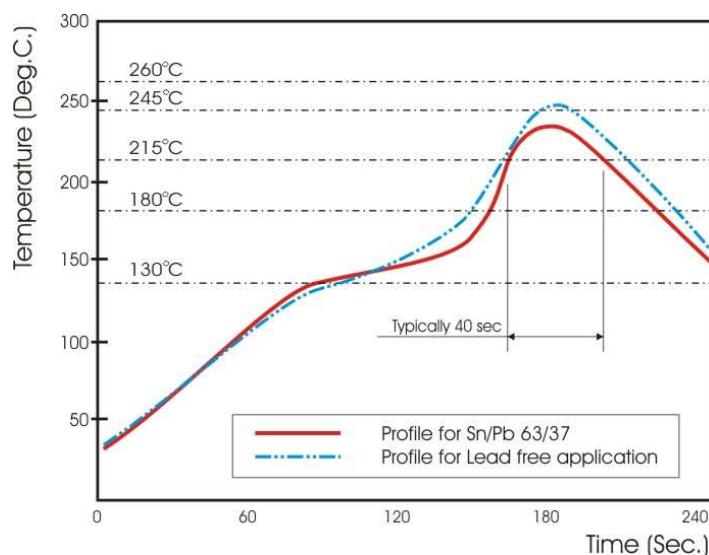

Fig 3. Infrared soldering profile

CATALOGUE NUMBERS

The resistors have a catalogue number starting with .

WW12	X	R020	F	T	L
Size code	Type code	Resistance code	Tolerance	Packaging code	Termination code
WW12 : 1206 WW08 : 0805 WW06 : 0603 WW04 : 0402	X : Normal	E96 +E24: R is first digit followed by 3 significant digits. 0.020Ω = R020 0.510Ω = R510 0.025Ω = R025 0.400Ω = no marking	J : ±5% G : ±2% F : ±1%	T : 7" Reel taping Q : 10" Reel taping G : 13" Reel taping	L = Sn base (lead free)

Tape packaging WW12, WW08, WW06 : 8mm width paper taping 5,000pcs per 7" reel; 10,000pcs per 10" reel; 20,000pcs per 13" reel.

WW04: 8mm width paper taping 10,000pcs per 7" reel; 20,000pcs per 10" reel; 70,000pcs per 13" reel.

**TEST AND REQUIREMENTS(JIS C 5201-1 : 1998)**

TEST	PROCEDURE	REQUIREMENT
Temperature Coefficient of Resistance(T.C.R) Clause 4.8	Natural resistance change per change in degree centigrade. $\frac{R_2 - R_1}{R_1(t_2 - t_1)} \times 10^6 \text{ (ppm/}^\circ\text{C)}$ $t_1 : 20^\circ\text{C}+5^\circ\text{C}-1^\circ\text{C}$ R_1 : Resistance at reference temperature R_2 : Resistance at test temperature	Refer to "QUICK REFERENCE DATA"
Short time overload (S.T.O.L) Clause 4.13	Permanent resistance change after a 5second application of a voltage 2.5 times RCWV or the maximum overload voltage specified in the above list, whichever is less.	$\Delta R/R$ max. $\pm(2\%+0.005\Omega)$ WW04X max $\pm(2\%+0.010\Omega)$
Resistance to soldering heat(R.S.H) Clause 4.18	Un-mounted chips completely immersed for 10 ± 1 second in a SAC solder bath at $260^\circ\text{C} \pm 5^\circ\text{C}$	no visible damage $\Delta R/R$ max. $\pm(1\%+0.005\Omega)$ WW04X max $\pm(1\%+0.010\Omega)$
Solderability Clause 4.17	Un-mounted chips completely immersed for 2 ± 0.5 second in a SAC solder bath at $235^\circ\text{C} \pm 5^\circ\text{C}$	good tinning (>95% covered) no visible damage
Temperature cycling Clause 4.19	30 minutes at $-55^\circ\text{C} \pm 3^\circ\text{C}$, 2~3 minutes at $20^\circ\text{C}+5^\circ\text{C}-1^\circ\text{C}$, 30 minutes at $+155^\circ\text{C} \pm 3^\circ\text{C}$, 2~3 minutes at $20^\circ\text{C}+5^\circ\text{C}-1^\circ\text{C}$, total 5 continuous cycles	no visible damage $\Delta R/R$ max. $\pm(1\%+0.005\Omega)$ WW04X max $\pm(1\%+0.010\Omega)$
Load life (endurance) Clause 4.25	1000 +48/-0 hours, loaded with RCWV or V_{max} in chamber controller $70 \pm 2^\circ\text{C}$, 1.5 hours on and 0.5 hours off	$\Delta R/R$ max. $\pm(3\%+0.005\Omega)$ WW04X max $\pm(5\%+0.010\Omega)$
Load life in Humidity Clause 4.24	1000 +48/-0 hours, loaded with RCWV or V_{max} in humidity chamber controller at $40^\circ\text{C} \pm 2^\circ\text{C}$ and 90~95% relative humidity, 1.5hours on and 0.5 hours off	$\Delta R/R$ max. $\pm(3\%+0.005\Omega)$ WW04X max $\pm(5\%+0.010\Omega)$
Bending strength Clause 4.33	Resistors mounted on a 90mm glass epoxy resin PCB(FR4); bending : 2 mm, once for 10 seconds	$\Delta R/R$ max. $\pm(1\%+0.005\Omega)$ WW04X max $\pm(1\%+0.010\Omega)$
Adhesion Clause 4.32	Pressurizing force: 5N, Test time: 10 ± 1 sec.	No remarkable damage or removal of the terminations
Insulation Resistance Clause 4.6	Apply the maximum overload voltage (DC) for 1minute	$R \geq 10G\Omega$
Dielectric Withstand Voltage Clause 4.7	Apply the maximum overload voltage (AC) for 1 minute	No breakdown or flashover



PACKAGING

Paper Tape specifications (unit :mm)

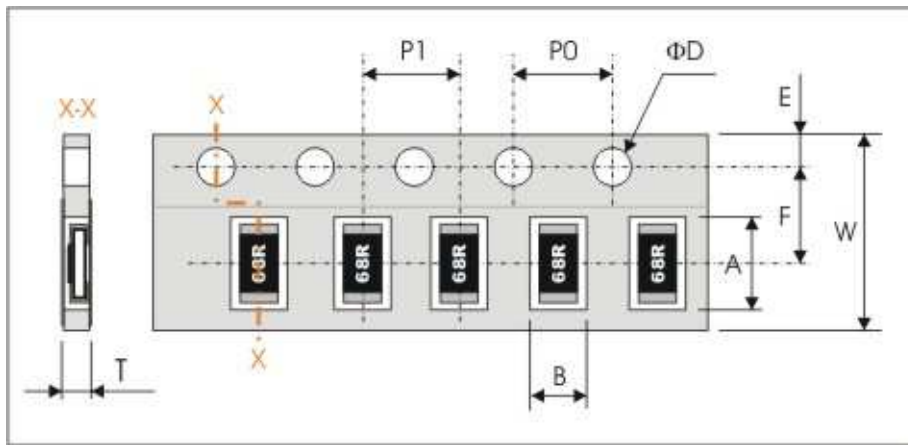

Series No.	A	B	W	F	E
WW12X	3.60±0.20	2.00±0.20	8.00±0.30	3.50±0.20	1.75±0.10
WW08X	2.40±0.20	1.65±0.20			
WW06X	1.90±0.20	1.10±0.20			
WW04X	1.20±0.10	0.70±0.10			

Series No.	P1	P0	ΦD	T
WW12X / WW08X	4.00±0.10	4.00±0.10	Φ1.50 ^{+0.1} _{-0.0}	Max. 1.0
WW06X				0.65±0.05
WW04X				0.40±0.05

Reel dimensions

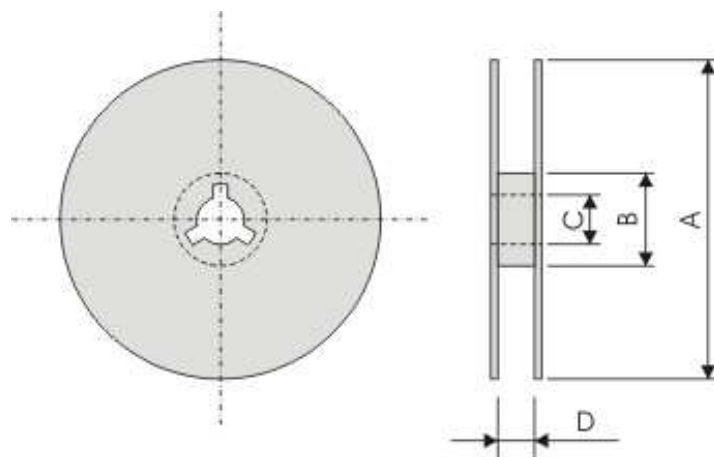

Symbol	A	B	C	D
7" reel	Φ178.0±2.0	Φ60.0±1.0	13.0±0.2	9.0±0.5
10" reel	Φ254.0±2.0	Φ100.0±1.0	13.0±0.2	9.0±0.5
13: reel	Φ330.0±2.0	Φ100.0±1.0	13.0±0.2	9.0±0.5