



CONQUER
功得電子



規格書

Specification For Approval

Spec NO. SFA029-14

型號： SEF(G)系列
快速型瓷管保險絲

Model： SEF(G) Series

Fast Acting Ceramic Surface Mount Fuse

Designed in accordance to UL248 standard.

Conquer Electronics Co., Ltd.

五股廠

24888 台灣新北市五股區五權五路26號(新北產業園區)
No.26, Wucyuan 5th Rd., Wugu Dist.,
New Taipei City 24888, Taiwan

T +886-2-8990-2189(代表號)
F +886-2-8990-2577
E cqservice@conquer.com.tw
W www.conquer.com.tw

北投廠

11259 台灣台北市北投區立德路120巷15號
No. 15, Lane 120, Lite Road, Peitou,
11259, Taipei, Taiwan

T +886-2-2895-8895(代表號)
F +886-2-2895-8880
E cqservice@conquer.com.tw
W www.conquer.com.tw

| REV. | Description | Date | Drawn | Designed | Checked | Approved |
|------|---|------------|-------|----------|---------|----------|
| 1 | (1) Issue | 2017.12.05 | 熊宏偉 | 邱俊傑 | 蔡進義 | 蕭煥益 |
| 2 | (1) 更新封面格式 (2) 更換LOGO (3) 修改項目順序 (4) 修改項目10重整安培數、安規、修改阻值中心變範圍及新增I ² t值 | 2019.5.22 | 林威廷 | 彭彥鳴 | 蔡進義 | 蕭煥益 |
| 3 | (1) 修改項目5 機械特性拉力強度敘述 (2) 修改項目9 新增包裝圖示及尺寸表 (3) 修改項目16.2 的英文敘述 | 2019.7.18 | 林威廷 | 彭彥鳴 | 邱信雄 | 蕭煥益 |
| 4 | (1) 新增 30A、35A、40A 冷阻值、I ² t 值、遮斷能力、It曲線圖、I ² t曲線圖 (2) 修改項目4 新增測試的印刷電路板 (3) 移除遮斷能力項目 (4) 修改項目9 整合遮斷能力、安規、冷阻值及I ² t值 | 2019.12.20 | 鄭人嘉 | 彭彥鳴 | 邱信雄 | 蕭煥益 |
| 5 | Change the place of production in label. | 2022.3.14 | 林威廷 | 彭彥鳴 | 邱信雄 | 蕭煥益 |

Conquer Electronics Co., LTD.

No.26, Wucyuan 5th Rd., Wugu Dist.,(New Taipei Industrial Park) New Taipei City 24888, Taiwan TEL:+886-2-8990-2189 (代表號) FAX:+886-2-8990-2577

Peitou Factory : No. 15, Lane 120, Lite Road, Peitou, 11248, Taipei, Taiwan. TEL: +886-2-2895-8895 (代表號) FAX:+886-2-2895-8880

E-mail: conqfuse@ms62.hinet.net Official Website: http://www.conquer.com.tw

~ 筒管狀保險絲 ~
Fuses for Instrument, Power and Telephone (Non-indicating)

1 **適用範圍 Applications:**

本標準適用於保護儀器、電源供應器和電話機用之筒管式熔斷保險絲。
 For protecting instruments, power supplies and telephone sets.

2 **形狀及尺寸 Shape & Dimensions:**

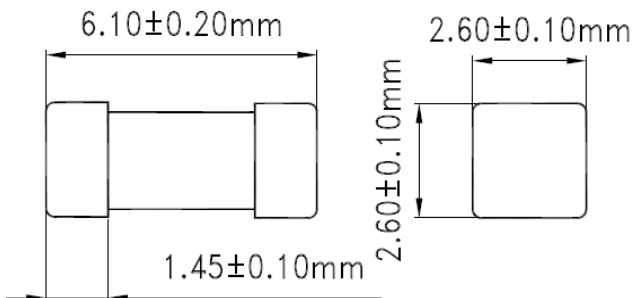

2.1 構造形狀 Structure & Shape : 如上圖 As shown in figure above

2.2 額定電壓 Voltage Rating : 125V/86V/80V/65V

2.3 額定電流 Ampere Rating: 0.062A~40A

3 **材料 Material:**

3.1 筒管本體: 不透明瓷管不可破裂或變形。

Tube (Body): Non-Transparent ceramic tube fuse. No breaking or deformation is allowed.

3.2 兩端銅帽: 需以導電率良好之黃銅為材料。

Two brass end caps: Made of brass of good conductivity.

3.3 銀合金線: 可熔體保險絲線。

Silver Alloy: Fuse element.

SEF Series

| Part Name 部品名稱 | Volume 數量 |
|-----------------------------|---|
| Square Cap 方型銅帽 | - Gold Plating - 鍍金 2 |
| Square Ceramic Tube 方型瓷管 | - Non-Transparent Ceramic - 不透明瓷管 1 |
| Fuse Element 可熔體 | 1 |

4 電氣特性 Electrical Characteristics:

4.1 負載容量:通過額定電流值100%(亦即 $1.0 \times I_n$ A)，能繼續通電至少4小時無任何熔化現象。
Loading Capacity: Loading 100% Rated Current (i.e. $1.0 \times I_n$ A) for flowing, and it's available to let current keep on flowing at least 4 hour without any melting. (Can keep 4 Hour minimum)

4.2 溫度特性 Temperature:
通過額定電流值100%(亦即 $1.0 \times I_n$ A)1.5小時，繼續維持原加之電流，每隔十分鐘測試一次，連續測三次，溫度不得升高，若使用熱偶式測量方法，(Thermocouple method) 則本體溫升在 175K 以下。

Loading the 100 % ($1.0 \times I_n$ A) for 1.5 hours, keep testing it with the original current every 10 minutes. Continue to test it for 3 times. The temperature is not allowed to be higher. The main temperature rise is below 175K by way of thermocouple method.

4.3 過載熔斷 Melting due to Overloading:

請參照下表。 Details as Follows Table.

(4.4 P.S.)

※最大熔斷時限 Operating Characteristics

For (圖一 Fig1)

| 安培數 Ampere Rating | 100% Rating | | 200% Rating | |
|----------------------|-------------|------|-------------|--------|
| | Min. | Max. | Min. | Max. |
| 0.062A~10A | 4 Hr | | | 5 sec |
| 12A~40A | 4 Hr | | | 60 sec |

基板Board: thickness 1.6mm

銅箔Copper: thickness 0.035mm 單面 (one side)

For (圖二 Fig2)(圖三 Fig3)

基板Board: thickness 1.6mm

銅箔Copper: thickness 0.070mm 單面 (one side)

4.4 用於測試的印刷電路板如圖1,圖2及圖3所示

The printed circuit board for testing is shown in Fig1, Fig2 and Fig3

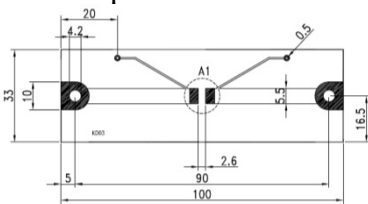

(圖一 Fig1)For 0.062A~15A

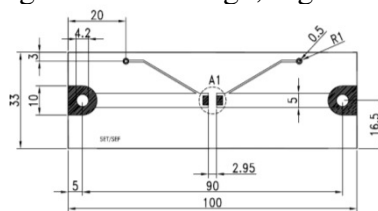

(圖二 Fig2)For 20A~25A

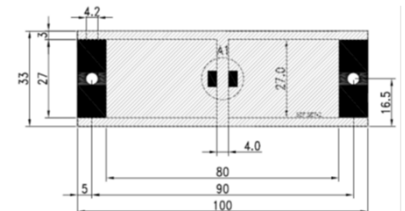

(圖三 Fig3)For 30A~40A

5 機械特性 Mechanical Properties:

拉力強度 Terminal Strength:

當施加軸拉力720g/cm於兩端銅帽，無鬆動或損壞現象發生。

caps are soldered (adhered) to withstand axial pulling force of 720g/cm without loosening or any harmfulness to firmly attachment.

6 突波實驗 Pulse Test:

為適應電感或電容性電路所產之暫態電流，本品於10倍額定電流的熔斷時間最少為 1ms。

In order to stand transient current caused by inductive or capacitive, the fuses are designed to have minimum clearing time of 1 millisecond at 1000% rated current.

7 耐久實驗 Endurance(On-Off Cycle Test):

本實驗乃保證產品之壽命與可靠度，施加60%額定電流之脈波，1分鐘ON，2分鐘OFF，1000次以後，本品不熔斷且內阻變化20%以下。

This test is designed to assure a reliable fuse, Controls are set giving 60% of rated ampere.

1 minute ON, 2 minutes OFF per time, the fuse will not open before 1000 times and the internal resistance change will be below 20%.

8 包裝 Packing:

1000 pcs (7'') / 盒, 20000 pcs / 箱。

內盒印明下列標示:料號、額定(電壓、電流、遮斷能力)及安規名稱。

包裝材料均符合RoHS或者HF的環保要求,且包裝材料不會和零件發生化學反應,造成不良。
1000 pcs (7'') in an inner box. 20000 pcs in an outer box.

The following items indicated on the box.

Mark: Catalog number; ratings (voltage, current, interrupting capacity), and safety mark.

The packing material conforms to RoHS or the HF environmental protection request.

And the packing material can't have the chemical reaction with the components.

8.1 Carrier Tape

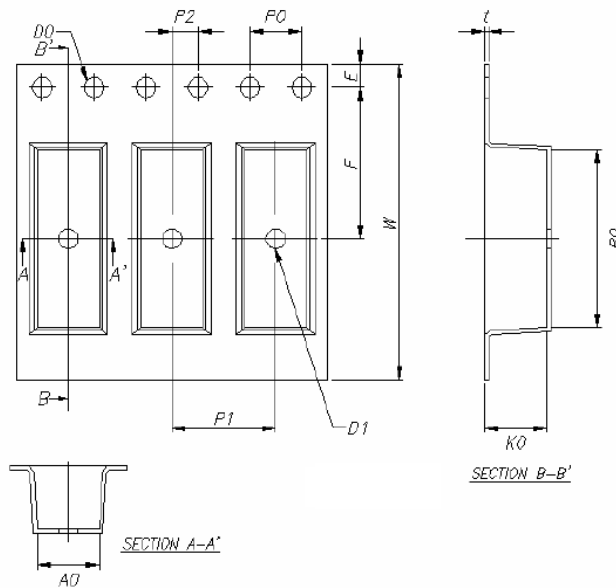

SEF Series

| Item | W | P1 | E | F | D0 | D1 | P0 | P2 | t | K0 | A0 | B0 |
|-----------|-------|-------|-------|-------|-------|-------|-------|-------|-------|-------|-------|-------|
| Spec | 12.00 | 4.00 | 1.75 | 5.50 | 1.50 | 1.50 | 4.00 | 2.00 | 0.25 | 2.80 | 2.90 | 6.50 |
| Tolerance | +0.20 | +0.10 | +0.10 | +0.05 | +0.10 | +0.10 | +0.05 | +0.05 | +0.05 | +0.10 | +0.10 | +0.10 |
| | -0.20 | -0.10 | -0.10 | -0.05 | -0.00 | -0.10 | -0.05 | -0.05 | -0.05 | -0.10 | -0.10 | -0.10 |

(Unit: mm)

8.2 Reel

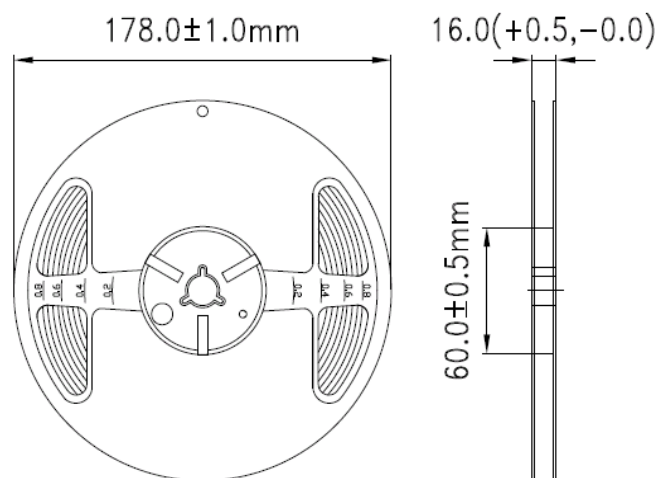







9 標記/安規認證 Mark/Agency Approvals:
SEF Series

印字方式--->

CQ F
** A

**安培數 Ampere Rating : 0.062A-40A

| Mark Approvals | Interrupting Rating |  |  |  | |
|-------------------|--|---|---|---|--|
| 0.062 A | 50A @ 125Vac 50A @ 125Vdc 300A @ 32Vdc | | * | | |
| 0.08 A | | | * | | |
| 0.1 A | | | | * | |
| 0.125 A | | | | * | |
| 0.2 A | | | | * | |
| 0.25 A | | | | * | |
| 0.315 A | | | | * | |
| 0.375 A | | | | * | |
| 0.4 A | | | | * | |
| 0.5 A | | | | * | |
| 0.75 A | | | | * | |
| 1 A | | | * | * | |
| 1.5 A | | | * | * | |
| 2 A | | | * | * | |
| 2.5 A | | | * | * | |
| 3 A | | | * | * | |
| 3.15 A | | | * | * | |

| Mark Approvals | Interrupting Rating |  |  |  | |
|-------------------|--|---|---|---|---|
| 3.5 A | 50A @ 125Vac 50A @ 125Vdc 300A @ 32Vdc | * | * | | |
| 4 A | | | * | | |
| 5 A | | | * | * | |
| 6 A | | | * | | * |
| 7 A | | | * | | * |
| 8 A | | | * | | * |
| 10 A | | | * | | * |
| 12 A | 50A @ 65Vac 50A @ 65Vdc 200A @ 86Vac | | | * | |
| 15 A | | 200A @ 86Vdc 300A @ 24Vdc | | | * |
| 20 A | 50A @ 65Vac 50A @ 65Vdc 300A @ 24Vdc | | | * | |
| 25 A | | | | * | |
| 30 A | 60A @ 80Vac 60A @ 80Vdc | | | * | |
| 35 A | | | | * | |
| 40 A | 80A @ 65Vac 80A @ 65Vdc | | | * | |

*: 有安規認證 With agency approvals

I²t is measured at 10 times of rated current

冷阻值範圍 & I²T Nominal Cold Resistance & I²T :

| Ampere Rating | Nominal Cold Resistance (Ohms) | Nominal Melting I ² t (A ² sec.) |
|---------------|--------------------------------|--|
| 0.062 A | 4.6571-8.6489 | 0.000961 |
| 0.08 A | 3.4818-6.4662 | 0.001000 |
| 0.1 A | 4.0716-7.5615 | 0.001500 |
| 0.125 A | 3.5070-6.5130 | 0.003120 |
| 0.2 A | 1.1874-2.2052 | 0.008000 |
| 0.25 A | 0.7735-1.4365 | 0.009380 |
| 0.315 A | 0.5988-1.1120 | 0.018000 |
| 0.375 A | 0.5124-0.9516 | 0.021100 |
| 0.4 A | 0.3496-0.6492 | 0.032000 |
| 0.5 A | 0.3334-0.6192 | 0.037500 |
| 0.75 A | 0.1698-0.3153 | 0.153100 |
| 1 A | 0.0985-0.1829 | 0.385000 |
| 1.5 A | 0.0791-0.1469 | 0.725000 |
| 2 A | 0.0416-0.0772 | 0.894000 |
| 2.5 A | 0.0269-0.0499 | 1.182000 |
| 3 A | 0.0233-0.0433 | 1.475000 |

| Ampere Rating | Nominal Cold Resistance (Ohms) | Nominal Melting I ² t (A ² sec.) |
|---------------|--------------------------------|--|
| 3.15 A | 0.0207-0.0385 | 1.655000 |
| 3.5 A | 0.0188-0.0348 | 2.055000 |
| 4 A | 0.0146-0.0272 | 3.882000 |
| 5 A | 0.0125-0.0233 | 5.480000 |
| 6 A | 0.0082-0.0152 | 8.520000 |
| 7 A | 0.0073-0.0135 | 9.931000 |
| 8 A | 0.0067-0.0124 | 18.820000 |
| 10 A | 0.0047-0.0087 | 22.500000 |
| 12 A | 0.0029-0.0055 | 43.200000 |
| 15 A | 0.0020-0.0038 | 112.500000 |
| 20 A | 0.0018-0.0033 | 141.520000 |
| 25 A | 0.0013-0.0025 | 246.553600 |
| 30 A | 0.0012-0.0023 | 365.400000 |
| 35 A | 0.0011-0.0021 | 420.910000 |
| 40 A | 0.0010-0.0019 | 503.680000 |

10 產品描述 Description :

| 描述 Description | 安培數 Ampere Rating |
|-------------------|----------------------|
| SEF ___A ___V(G) | 0.062A~40A |

例: SEF A V (G)
 1 2 3 4

- 1 系列品名 Series Model : SEF
- 2 安培數 Ampere Rating : 0.062A~40A
- 3 伏特數 Voltage Rating : 125V / 86V / 80V / 65V
- 4 鍍金銅帽 Gold Plated Cap : (G)

5 貼紙 LABEL

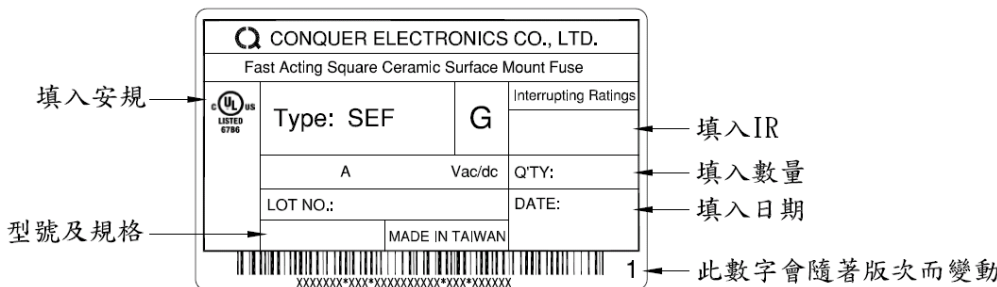

Conquer Electronics Co., LTD.

No.26, Wucyuan 5th Rd., Wugu Dist.,(New Taipei Industrial Park) New Taipei City 24888, Taiwan TEL:+886-2-8990-2189 (代表號) FAX:+886-2-8990-2577

Peitou Factory : No. 15, Lane 120, Lite Road, Peitou, 11248, Taipei, Taiwan. TEL: +886-2-2895-8895 (代表號) FAX:+886-2-2895-8880

E-mail: conqfuse@ms62.hinet.net Official Website: http://www.conquer.com.tw

11 建議生產參數(無鉛焊錫使用):

Recommended Applications Parameters(for lead-free solder alloy):

- 11.1 Hand Soldering : 350°C, 3sec. max. (Do not touch the terminal cap.)
- 11.2 Wave Soldering : 260°C, 3sec. max.

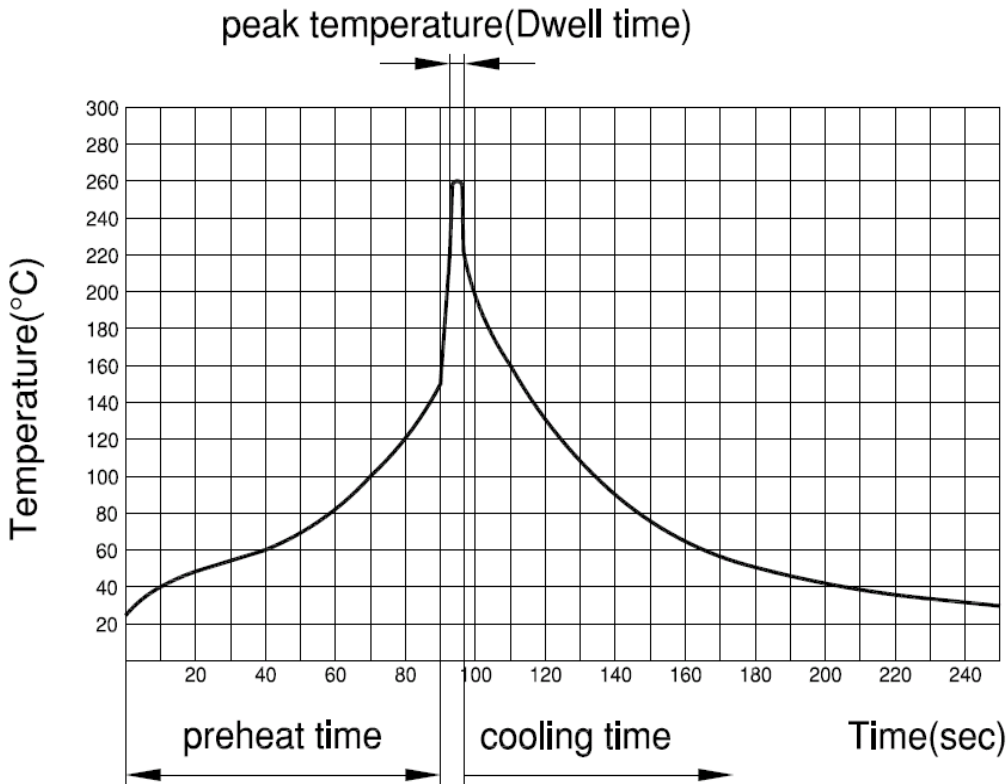

| Wave soldering Condition | | Lead-free Assembly |
|--------------------------|---------------------|--------------------|
| Pre-Heat | Temperature Max. | 150°C |
| | Time (Min. to Max.) | 60 - 90 sec |
| Solder Pot Temperature | | 260°C max. |
| Solder Dwell Time | | 2 - 3 sec |

11.3 Reflow Soldering : 260°C, 30sec. max. See detail in the soldering profile.

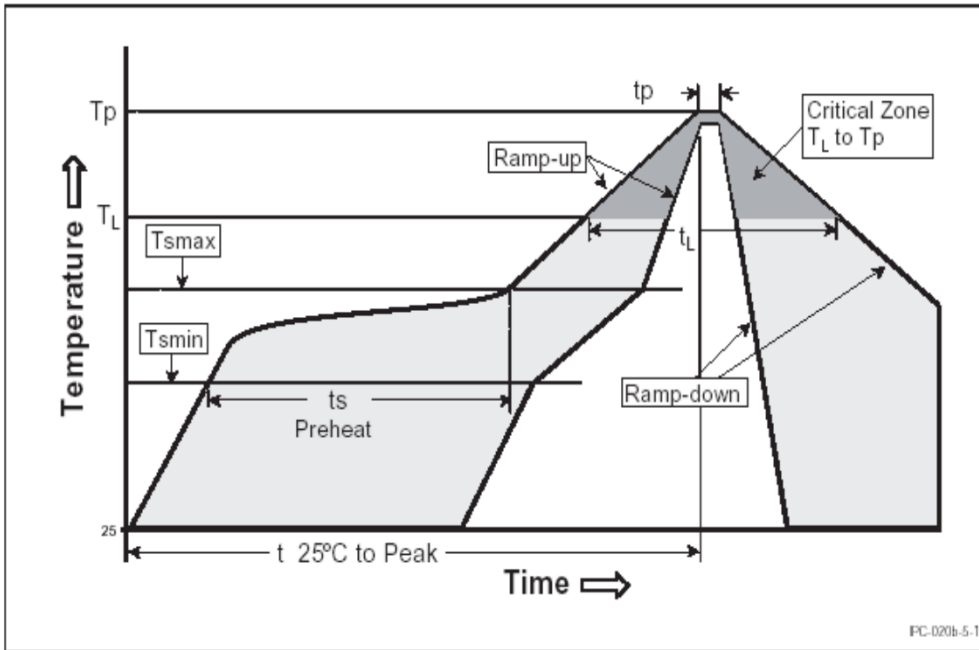

PC-020b-5-1

| Reflow Condition | | Lead-free Assembly |
|--|--|--------------------|
| Pre-Heat | Temperature Min. (T _{s (min)}) | 150°C |
| | Temperature Max. (T _{s (max)}) | 200°C |
| | Time (Min to Max) (t _s) | 60 - 180 sec. |
| Average Ramp-up Rate (Liquidus Temp (T _L) to peak) | | 3°C / sec max. |
| T _{s (max)} to T _L -Ramp-up Rate | | 5°C / sec max. |
| Reflow | Temperature (T _L) (Liquidus) | 217°C |
| | Time (t _L) | 60 - 150 sec. |
| Peak Temperature (T _p) | | 260 +0/-5°C |
| Time within 5°C of actual peak Temperature (t _p) | | 10 - 30 sec. |
| Ramp-down Rate | | 6°C / sec max. |
| Time 25°C to peak Temperature (t 25°C to peak) | | 8 min max. |
| Do not exceed | | 260°C |

12 It曲線圖 Time Current Characteristic Curve:

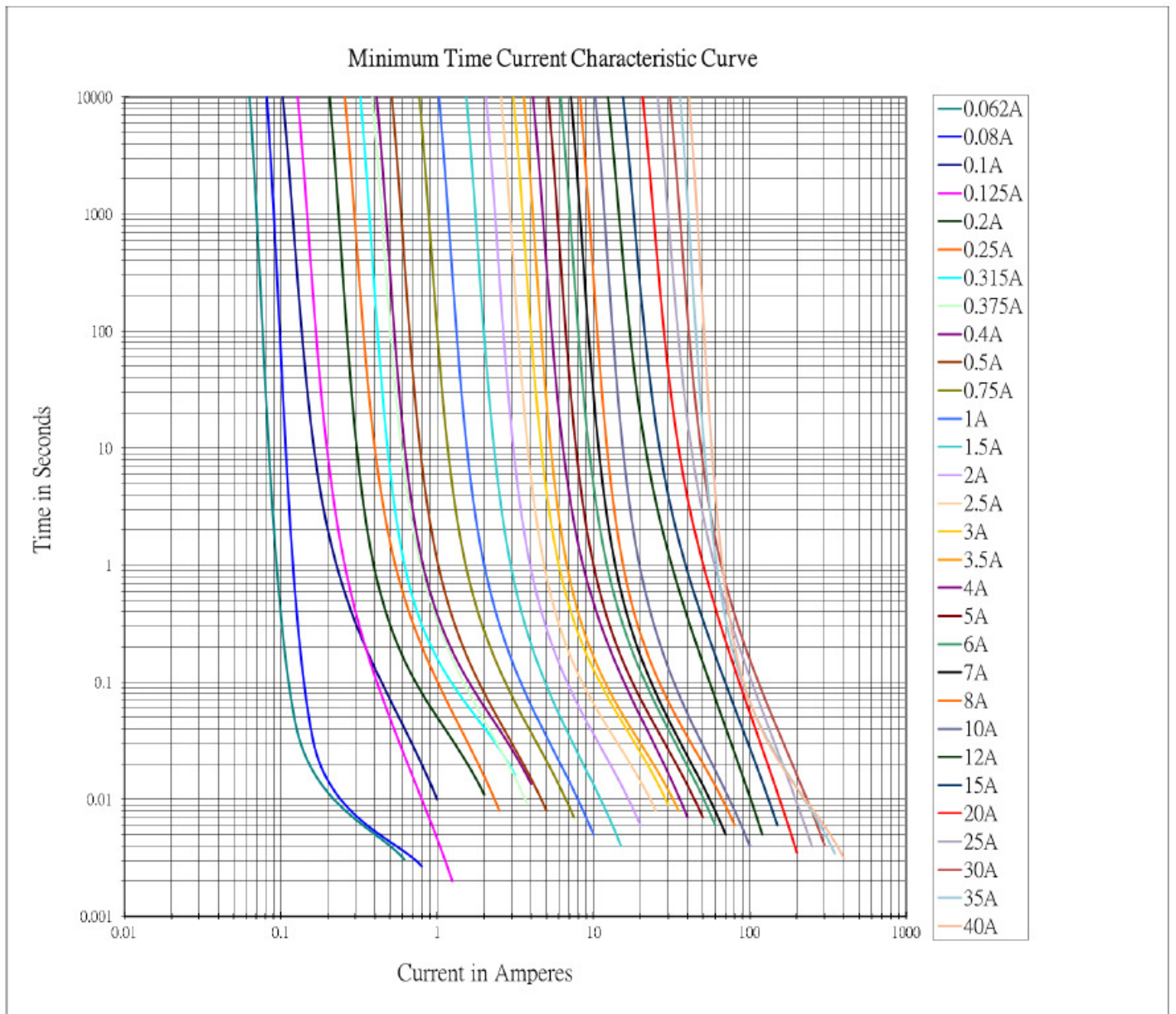

Conquer Electronics Co., LTD.

Wugu Factory : No. 26, Wucyuan 5th Road, Wugu Township, Taipei County 248, Taiwan. TEL:+886-2-8990-2189 (代表號) FAX:+886-2-8990-2577

Peitou Factory : No. 15, Lane 120, Lite Road, Peitou, 11248, Taipei, Taiwan. TEL: +886-2-2895-8895 (代表號) FAX:+886-2-2895-8880

E-mail: conqfuse@ms62.hinet.net Official Website: <http://www.conquer.com.tw>

13 I^2t 曲線圖 Average melting I^2t curves:

Average Melting I^2t Curves

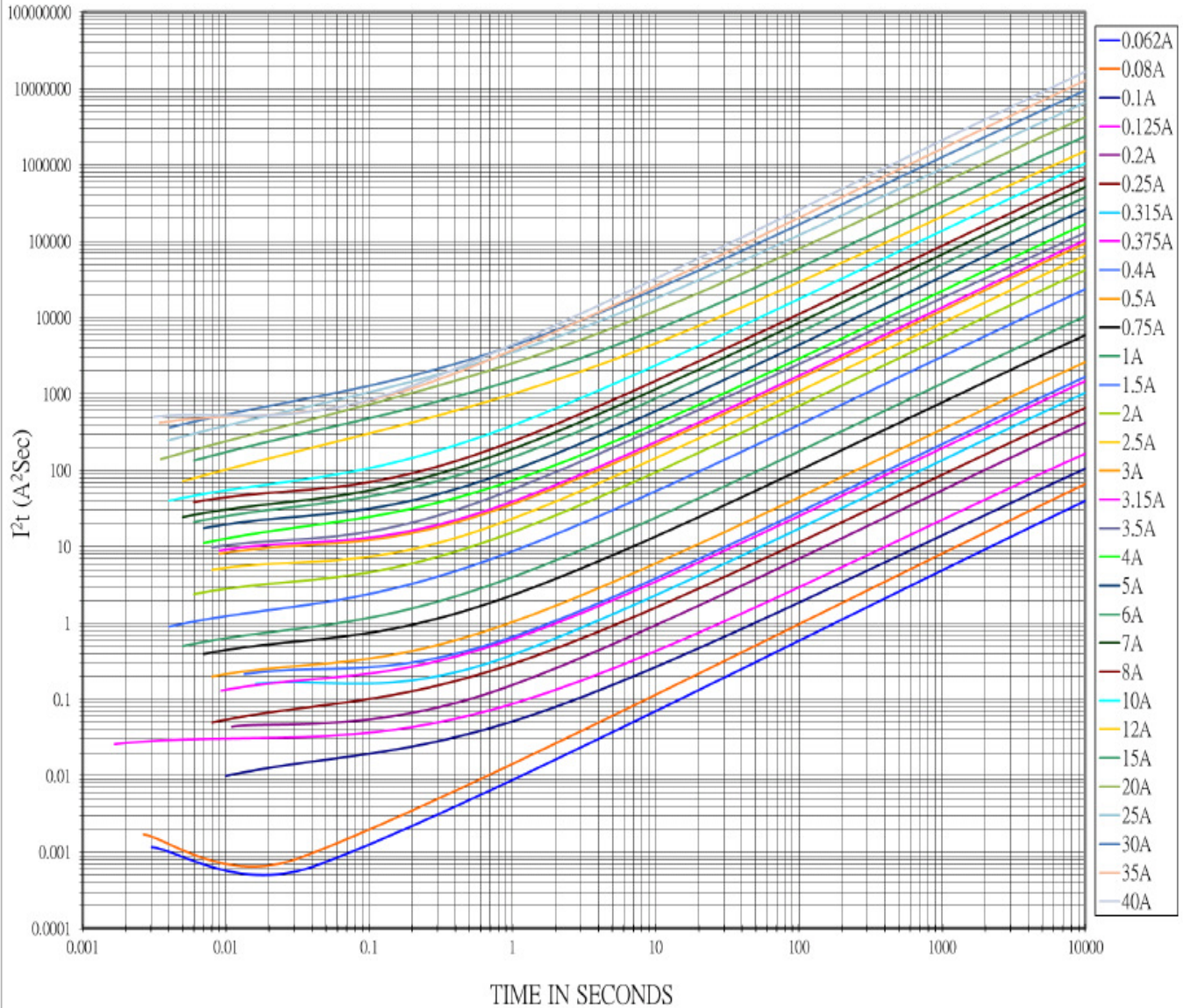

Conquer Electronics Co., LTD.

Wugu Factory : No. 26, Wucyuan 5th Road, Wugu Township, Taipei County 248, Taiwan. TEL:+886-2-8990-2189 (代表號) FAX:+886-2-8990-2577

Peitou Factory : No. 15, Lane 120, Lite Road, Peitou, 11248, Taipei, Taiwan. TEL: +886-2-2895-8895 (代表號) FAX:+886-2-2895-8880

E-mail: conqfuse@ms62.hinet.net Official Website: <http://www.conquer.com.tw>

14 信賴性作業規定 Product Characteristics:

Product Characteristics & Reliability Tests

| Test item | Test Description & Reference |
|--|--|
| Humidity unload test | MIL-STD-202G · Method 103B · Test Condition A Heat (85±0.5°C) & High Humidity (85±1% RH), 240 hours, ΔR<15% |
| Thermal shock test | MIL-STD-202G, Method 107g · Test Condition B Temperature setup : 25°C ~ -65°C ~ 25°C ~ 125°C Time setup : -65°C(30min)~25°C(5min)~125°C(30min)~ 25°C(5min) 5 cycles, ΔR<15% |
| Vibration test | MIL-STD-202G · Method 201A Frequency setup : 10 ~ 55 ~ 10 Hz Time setup : 1 Minutes/cycle (X-Y-Z,120 Cycles) 6 hrs, ΔR<15% |
| Salt spray test | MIL-STD-202G · Method 101E · Test Condition A Salt spray concentration : 5 ± 1% Test liquid temperature : 35 ± 0.5°C 96 hrs, ΔR<15% |
| Solderability test (for reflow soldering condition) | Reference IEC 60068-2-58 Temperature setup : 235 ± 5°C, 10 ± 1 sec After test terminal electrode wetting area must be greater than 95% |
| Resistance to solder heat test (for reflow soldering condition) | Reference IEC 60068-2-58 Temperature setup : 235± 5°C, 30± 5 sec ΔR<15% |
| Bending test | Reference IEC 60127-4 The board shall be bent by 1mm at a rate of 1mm/sec ΔR<15% |

Conquer Electronics Co., LTD.

No.26, Wucyuan 5th Rd., Wugu Dist.,(New Taipei Industrial Park) New Taipei City 24888, Taiwan TEL:+886-2-8990-2189 (代表號) FAX:+886-2-8990-2577

Peitou Factory : No. 15, Lane 120, Lite Road, Peitou, 11248, Taipei, Taiwan. TEL: +886-2-2895-8895 (代表號) FAX:+886-2-2895-8880

E-mail: conqfuse@ms62.hinet.net Offical Website: <http://www.conquer.com.tw>

15 其他 Other:

15.1 除非另有指定，上述機械、電器特性，係於常溫，標準狀況下測試之。

Unless otherwise specified, all tests to be performed at 25±5°C and 35-75% RH.

15.2 於標準狀況下儲放一年內，本品乃確保上述機械與電氣之特性。

Store under normal conditions for one year, the fuse could meet the electrical and mechanical characteristics in clause 4 and 5.

15.3 使用於此產品之材料中，使用高溫熔化型之焊錫，此焊錫成份中鉛含量大於85%，故此產品符合RoHS指令要求之焊錫含鉛量超過85%之排除條款規範。

Because the materials used in these fuses include high melting temperature type solder and this solder contains more than 85% lead (Pb), so these products can conform to the exempts of the requirements of RoHS Directive .

15.4 工作溫度：-55°C to +125°C

Operating Temperature : -55°C to +125°C